

# Digital Display Proportional Valve Driver

## LE PGX

Direct DIN solenoid mount  
PG9 cable gland connection

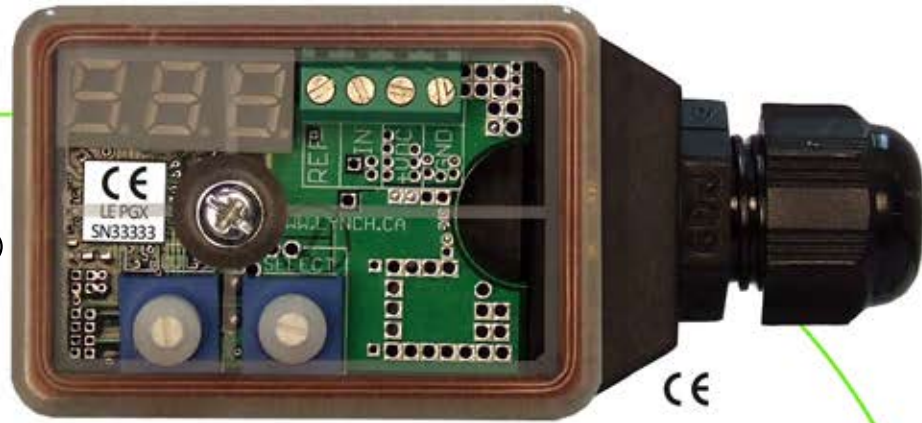

### Features and Benefits

- ▶ Microcontroller design
- ▶ Independent adjustments (Incl. ramp up & ramp down)
- ▶ 3 digit extra bright seven segment LED display
- ▶ Large, easy-to-use adjustments and readout
- ▶ Display and adjust actual values (Current & Voltage)
- ▶ Wide range of supply voltage
- ▶ User selectable input type through menu setup (ex: 0 to 5V, 0 to 10V, 4 to 20mA)
- ▶ Wide ramp time range (0 to 99.5 Sec)
- ▶ Simple control with analog input, Locally supplied reference voltage
- ▶ Energy efficient PWM circuit/no heat sink required
- ▶ Current sensing maintains output regardless of changes in supply voltage and coil resistance
- ▶ Electronic limiting circuit/short circuit proof
- ▶ Reverse polarity, Command Input protection
- ▶ Load can be connected & disconnected live
- ▶ Mounting: Direct on Solenoid DIN 43650-A/ISO 4400
- ▶ Easy troubleshooting/cable length not an issue

### LE PGX Standard Specifications

<b>Operating voltage:</b>	9 to 36 VDC
<b>Maximum output current:</b>	3.00Amps
<b>Input signal:</b>	5V, 10V, 4 to 20mA
<b>Maximum ramp time:</b>	99.5 Sec
<b>PWM / Dither frequency:</b>	40-450Hz
<b>Linearity:</b>	1%
<b>Operating Temperature:</b>	-40° to +75° Celsius
<b>Protection Grade:</b>	IP65 (See note on the next page for additional information)

### Several Forms Available

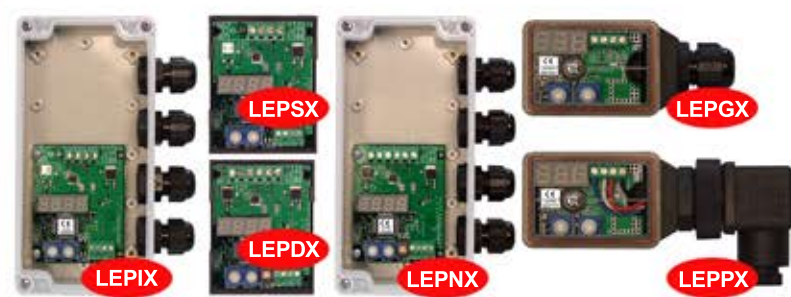

Note: Customization of functionality and enclosure type are available on request.

**PART NUMBER SYSTEM** Proportional Solenoid Driver, Single, solenoid mount with PG9 cable gland **Example: LE PGX**

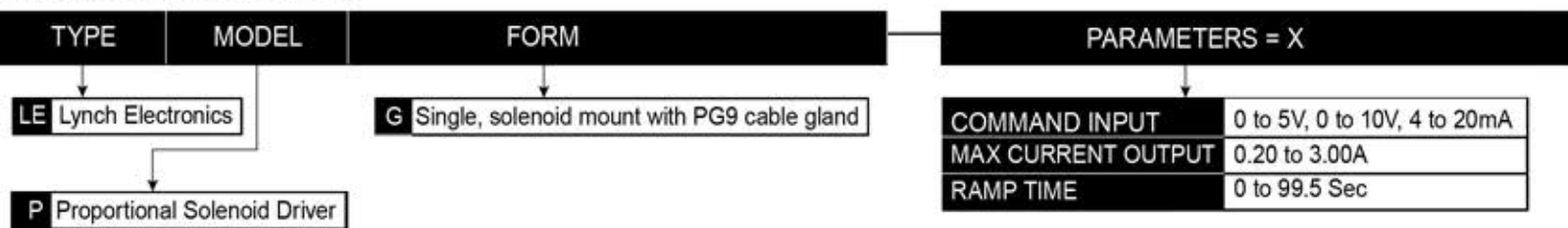

Contact Us For More Information

LE PGX-0212-B

<p><b>Toll Free</b> Tel: 1 (888) 626-4365 Fax: 1 (800) 263-5807</p>	<p><b>Local &amp; International</b> Tel: +1 (905) 363-2400 Fax: +1 (905) 363-1191</p>	<p><b>Address</b> 1799 Argentia Road Mississauga, Ontario L5N 3A2</p>	<p><b>Online</b> www.Lynch.ca sales@lynch.ca</p>
-----------------------------------------------------------------------------	-----------------------------------------------------------------------------------------------	-------------------------------------------------------------------------------	----------------------------------------------------------

# LE PGX

Direct DIN solenoid mount, PG9 cable gland connection

A Division of Lynch Fluid Controls

## LE PGX DIMENSIONAL DRAWING

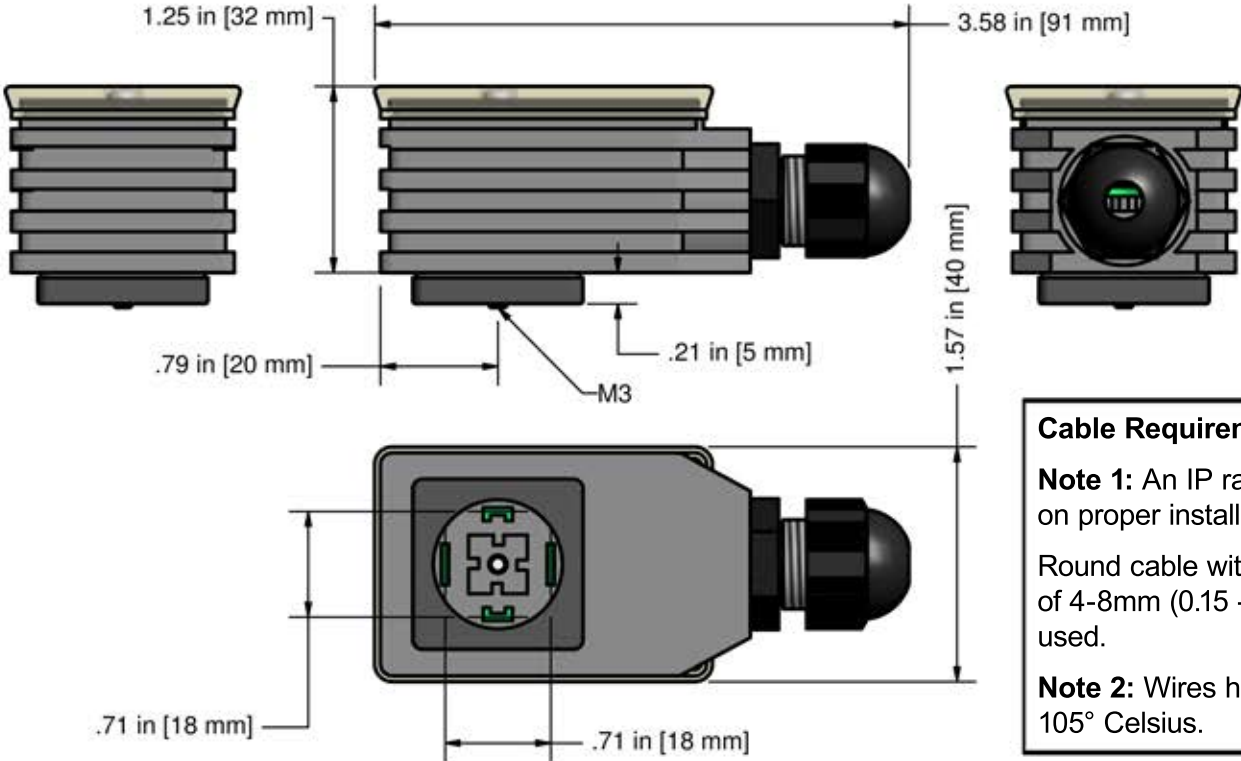
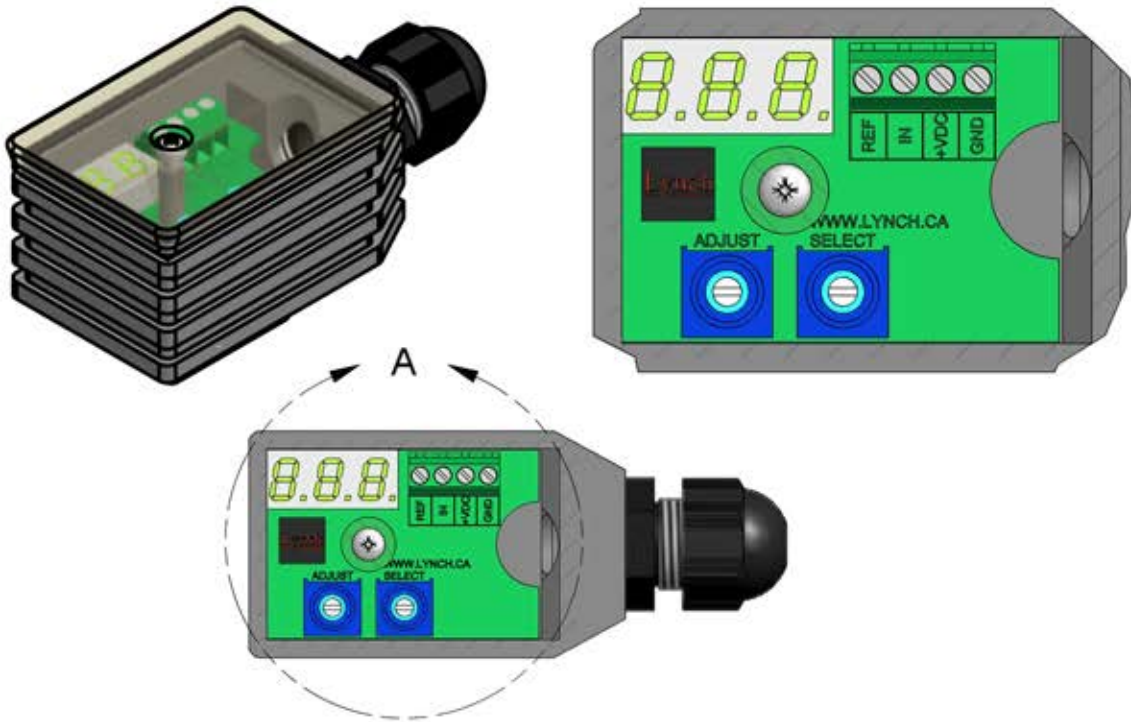

**Cable Requirements**

**Note 1:** An IP rating is dependent on proper installation by the user. Round cable with a diameter range of 4-8mm (0.15 - 0.30") must be used.

**Note 2:** Wires have to be rated to 105° Celsius.

### Contact Us For More Information

**Toll Free**  
Tel: 1 (888) 626-4365  
Fax: 1 (800) 263-5807

**Local & International**  
Tel: +1 (905) 363-2400  
Fax: +1 (905) 363-1191

**Address**  
1799 Argentia Road  
Mississauga, Ontario L5N 3A2

**Online**  
www.Lynch.ca  
sales@lynch.ca

LE PGX-0109-A

# LE PGX

Direct DIN solenoid mount, PG9 cable gland connection



Electronics

A Division of Lynch Fluid Controls

## LE PGX SCHEMATICS

### EXTERNAL INPUT SIGNAL CONNECTION

"in" set to "10"

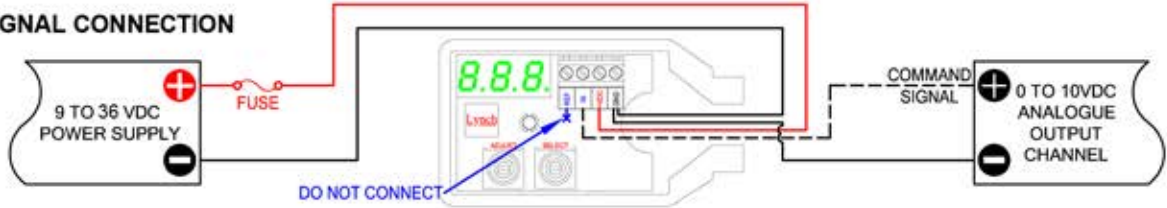

### POTENTIOMETER CONNECTION

"in" set to "5"

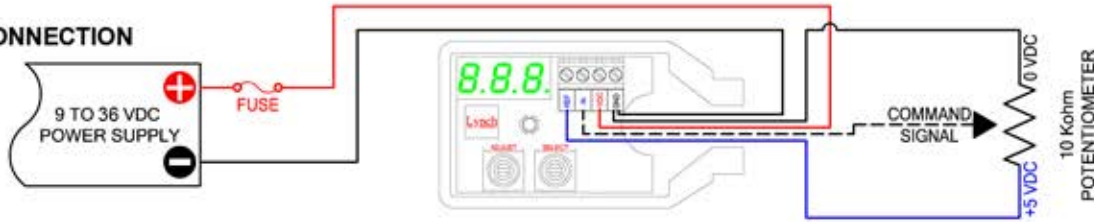

### RAMP UP & DOWN ONLY OPERATION

"in" set to "5"

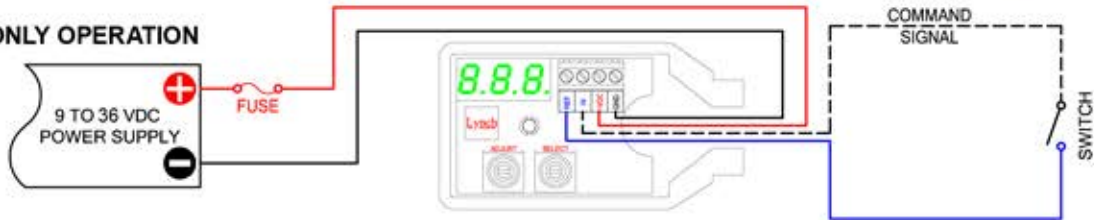

### EXTERNAL INPUT SIGNAL CONNECTION

"in" set to "420"

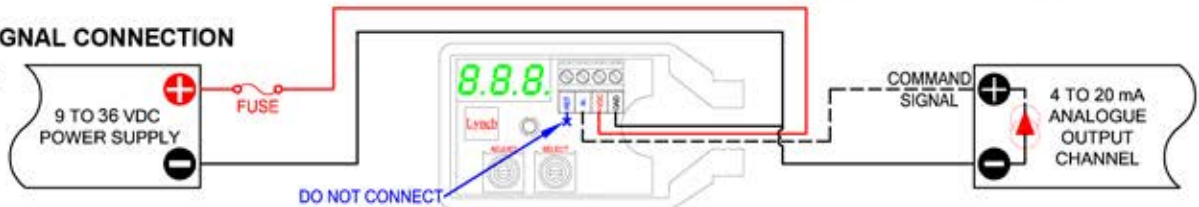

### TWO WIRE TRANSMITTER INPUT CONNECTION

"in" set to "420"

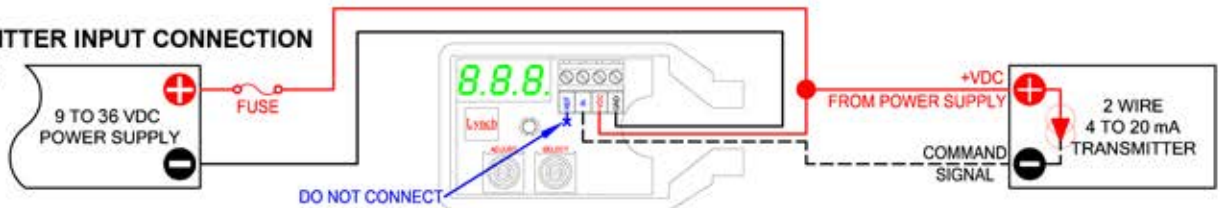

**PLEASE NOTE:** For "0 to 5 VDC" & "0 to 10 VDC" command input drivers, it is recommended to use independent negative conductors for power supply and analogue output channel (PLC/PC) to maintain command signal accuracy due to voltage drop on long cable runs.



This product has been designed and tested to meet specific standards outlined in the European Electromagnetic Compatibility Directive (EMC) 2004/108/EC  
Emission: EN 61000-6-4: 2007  
Immunity: EN 61000-6-2: 2005, EN 61000-4-2, EN 61000-4-4, EN 61000-4-6

### Contact Us For More Information

**Toll Free**  
Tel: 1 (888) 626-4365  
Fax: 1 (800) 263-5807

**Local & International**  
Tel: +1 (905) 363-2400  
Fax: +1 (905) 363-1191

**Address**  
1799 Argentia Road  
Mississauga, Ontario L5N 3A2

**Online**  
www.Lynch.ca  
sales@lynch.ca

LE PGX-0109-A

# LE PGX

Direct DIN solenoid mount, PG9 cable gland connection



A Division of Lynch Fluid Controls

## LE PGX SETTING & RANGE GRAPHS

**H:** HIGH,  
Maximum Current output, **0.20 to 3.00** [Amps]

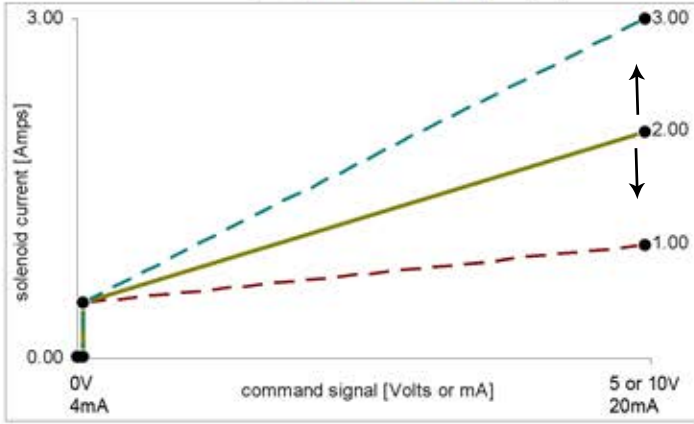

**Lo:** LOW,  
Minimum Current Output, **0.00 to 2.99** [Amps]

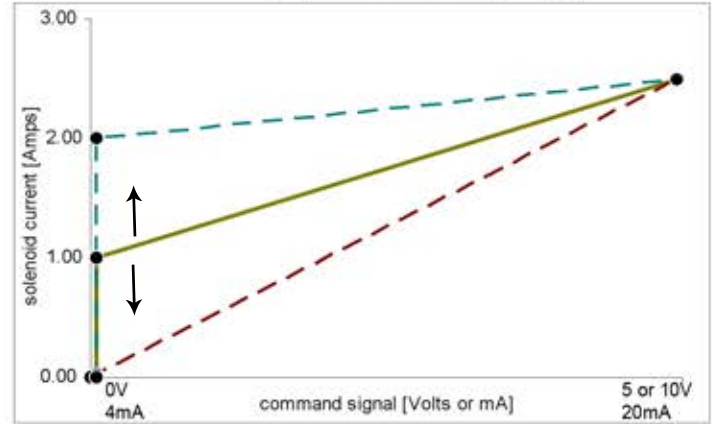

**rUP:** RAMP UP,  
Time for Output to Increase from min to max, **0.0 to 99.5** [SEC]

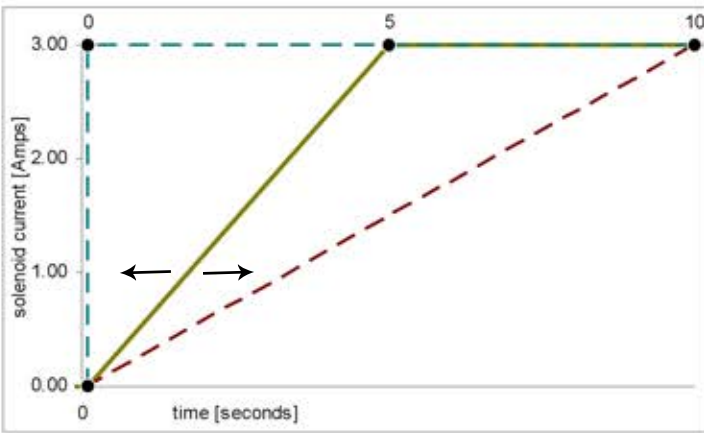

**rDn:** RAMP DOWN,  
Time for Output to Decrease from max to min, **0.0 to 99.5** [SEC]

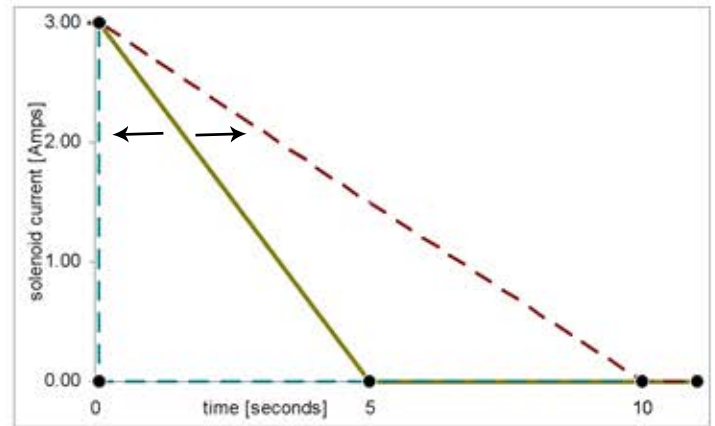

**Cdb:** COMMAND DEADBAND,  
Output disabled if command signal less than deadband, **0 to 5** [%]

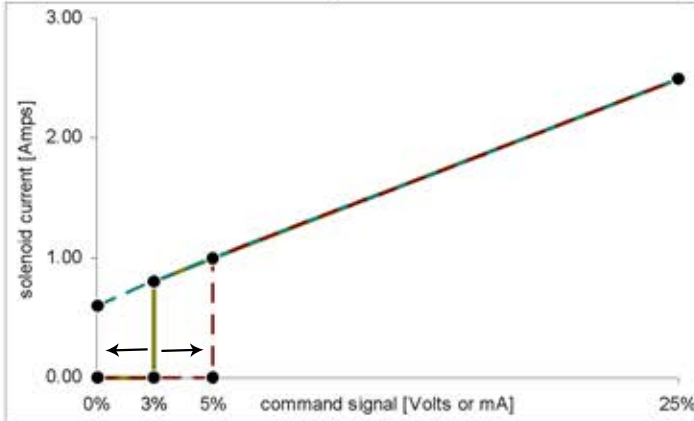

**dFr:** DITHER FREQUENCY,  
**40** (40Hz) to **450** (450Hz)

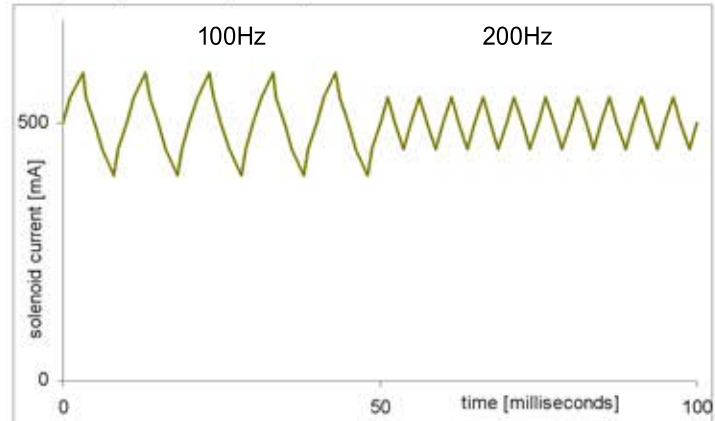

### Contact Us For More Information

**Toll Free**  
Tel: 1 (888) 626-4365  
Fax: 1 (800) 263-5807

**Local & International**  
Tel: +1 (905) 363-2400  
Fax: +1 (905) 363-1191

**Address**  
1799 Argentia Road  
Mississauga, Ontario L5N 3A2

**Online**  
[www.Lynch.ca](http://www.Lynch.ca)  
[sales@lynch.ca](mailto:sales@lynch.ca)

LE PGX-0109-A

# LE PGX

Direct DIN solenoid mount, PG9 cable gland connection

A Division of Lynch Fluid Controls

## LE PGX SET-UP PROCEDURE

(NOTE: Prior to setting up parameters, you must select proper Input Signal setting for your system)

Available Input Signal options

- in: 10 (0 to 10V) <=Default
- in: 5 (0 to 5V)
- in: 420 (4 to 20mA)

\*\*\*Applying improper Input Signal to wrong setting on the Driver may be damaging to Driver Unit and may cause driver to fault to Error Status mode\*\*\*

### SET-UP

1. At power up, the display will show either the output current signal or the input signal (Default display setting shows the output signal). The decimal point will be flashing.
2. Rotate SELECT to enter the set-up mode
3. When you reach the setting you want to modify, rotate ADJUST up or down to the desired value.
4. To modify another setting, rotate SELECT again and repeat.
5. The Driver is fully functional during the set-up procedure with any adjustments effective immediately.
6. In order to write the new settings in the memory and return to normal mode of operation, rotate SELECT until the display shows **SR** and then rotate ADJUST or wait for 100 seconds.
7. If you do not want to save the new settings you have just modified, you must disconnect the Driver from the power supply before the end of the 100 seconds to restore the previous settings.
8. After saving parameters to memory, the decimal point will be flashing and the Driver display will be back showing either the output current signal or input signal depending on your **di** selection.
9. To start over completely, you can restore the factory settings by rotating SELECT to **rFP** and then rotate ADJUST up past 10 for the display to reset. (NOTE for Step 9: You may have to adjust your Input Signal Setting again if you reset to factory settings.)

## LE PGX SETTINGS & RANGE

- Hi:** HIGH, Maximum Current Output, 0.20 to 3.00 [Amps]
- Lo:** LOW, Minimum Current Output, 0.00 to 2.99 [Amps] (See: NOTE 1)
- rUP:** RAMP UP, Time for Output to Increase from min to max, 0.0 to 99.5 [SEC]
- rDn:** RAMP DOWN, Time for Output to decrease from max to min, 0.0 to 99.5 [SEC]
- Cdb:** COMMAND DEADBAND, Output disabled if command signal less than deadband, 0 to 5 [%]
- dFr:** DITHER FREQUENCY, 40 (40Hz) to 450 (450Hz)
- in:** INPUT SIGNAL SELECTION, 5 (0 to 5V) or 10 (0 to 10V) or 420 (4 to 20mA)
- di:** DISPLAYED SIGNAL FOR TROUBLESHOOTING, 0 (command signal in [Volts] or [milliAmps]) or 1 (solenoid current in [Amps])
  - \*\*Flashing decimal point is an indicator for present display mode\*\*
  - Fast Flashing decimal point, several flashes per second indicates **di** = 0
  - Slow Flashing decimal point, 1 per second indicates **di** = 1
  - No Flashing decimal point or No decimal point indicates display in SETTING/ADJUST mode
- SR:** SAVE SETTINGS
- rFP:** RESET FACTORY PARAMETERS (See: NOTE 2)
- Err:** ERROR DETECTION STATE, Short Circuit, Reverse polarity protection and detection
  - Error 0 - No Errors
  - Error 1 - Overcurrent in driver likely due to short circuit in Solenoid
  - Error 2 - Current exceeding 20mA in "4 to 20mA" input mode
- Clr:** CLEAR ERROR, Clears Driver of Error State (See: NOTE 2)

**NOTE 1:** When adjusting the HI and LO parameters, note the HI parameter value cannot be adjusted below the LO parameter value as well the LO parameter value cannot exceed the HI parameter value.

**NOTE 2:** Adjust Parameter Value up past 9 to operate this command setting

## OPTIONAL FEATURES (Please contact us for more information)

- Pcd:** PASSWORD, Adjust code for Password Protection settings for Lock or Unlock
- Loc:** LOCK, Locks driver to LOCKED state with Password set in **Pcd**
- UnL:** UNLOCK, Unlocks driver with correct Password set in **Pcd**
  - \*\*Only available in LOCKED state mode\*\*